

Infrared Laser Diode

ADL-80X01TZ
6-2D-LD80-002_Rev.03

808nm 300mW High Power Operation

• Features

1. Low threshold current
2. Low operation current
3. High pumping efficiency
4. Stable wavelength
5. High reliability

• Applications

1. Pumping source for DPSS green laser
2. Medical applications

• Absolute maximum ratings

Parameter	Symbol	Condition	Rating	Unit
Light output power	P_O	CW	300	mW
Reverse voltage (LD)	V_{RL}	-	2	V
Case temperature	T_C	-	-10~+50	°C
Storage temperature	T_S	-	-40~+85	°C

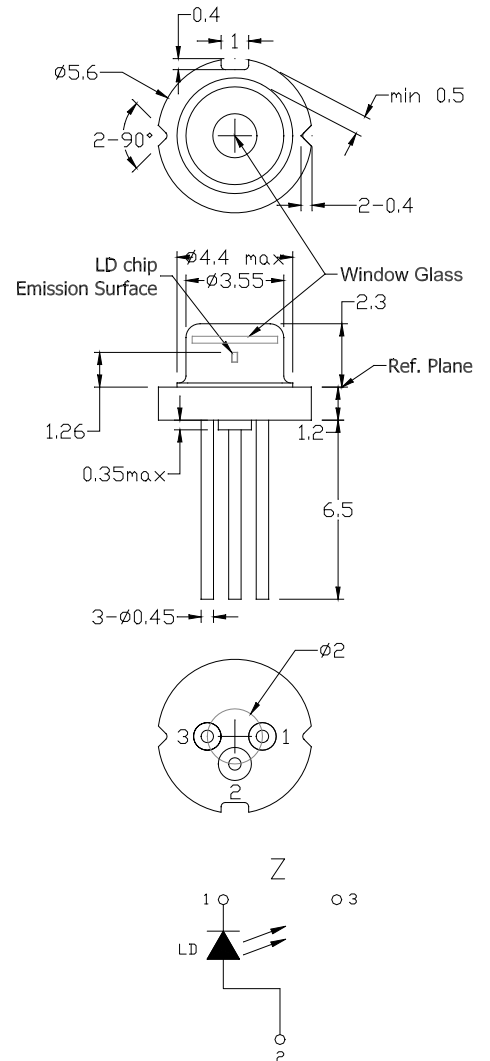

• Electrical and optical characteristics ($T_C=25^\circ\text{C}$)

Parameter	Symbol	Min.	Typ.	Max.	Unit	Conditions (CW)
Peak wavelength	λ	805	808	811	nm	$P_o=300\text{mW}$
Threshold current	I_{th}	-	65	80	mA	
Operating current	I_{op}	-	320	360	mA	
Operating voltage	V_{op}	-	1.95	2.2	V	$P_o=250\text{-}300\text{mW}$
Differential efficiency	η	0.8	1.2	-	mW/mA	
Parallel divergence angle	$\theta_{ }$	-	8	11	deg	$P_o=300\text{mW}$
Perpendicular divergence angle	θ_{\perp}	-	39	48	deg	
Parallel FFP deviation angle	$\Delta\theta_{ }$	-3	0	+3	deg	
Perpendicular FFP deviation angle	$\Delta\theta_{\perp}$	-5	0	+5	deg	
Emission point accuracy	$\Delta x \Delta y \Delta z$	-80	0	+80	um	

• Precautions

- * Do not operate the device above maximum ratings. Doing so may cause unexpected and permanent damage to the device.
- * Take precautions to avoid electrostatic discharge and/or momentary power spikes. A change in the characteristics of the laser or premature failure may result.
- * Proper heat sinking of the device assures stability and lifetime. Always ensure that maximum operating temperatures are not exceeded.
- * Observing visible or invisible laser beams with the human eye directly, or indirectly, can cause permanent damage. Use a camera to observe the laser.
- * No laser device should be used in any application or situation where life or property is at risk in event of device failure.
- * Specifications are subject to change without notice. Ensure that you have the latest specification by contacting us prior to purchase or use of the product.

* For reference only. Contents above are subject to change without notice.

Contact

For US, Canada Ayase America Inc. e-mail: info@ayaseamerica.com +1-408-988-5277
 For EU Ayase Europe GmbH e-mail: info@ayase-europe.de +49-0-6122-533-811
 For Japan Ayase Co., Ltd. e-mail: info@ayasecorporation.com +81-45-532-9501

Infrared Laser Diode

ADL-80X01TZ
6-2D-LD80-002_Rev.03

Notice: Arima Lasers proposes to operate ADL-80X01TZ by the external APC circuit

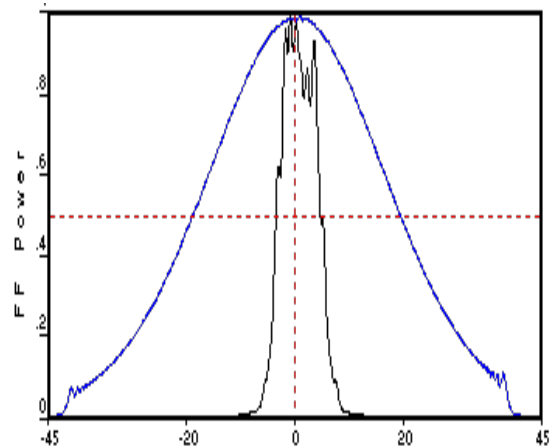
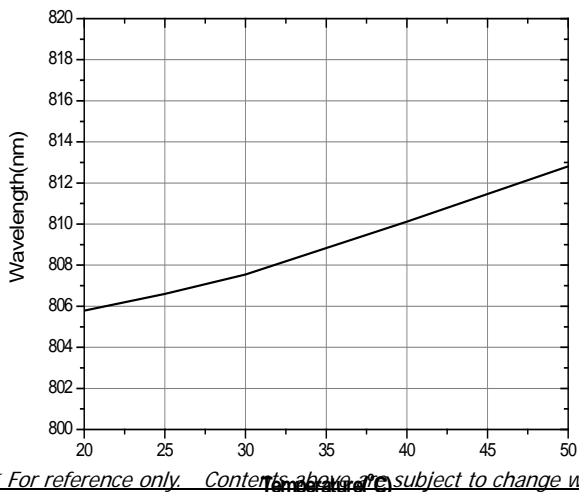
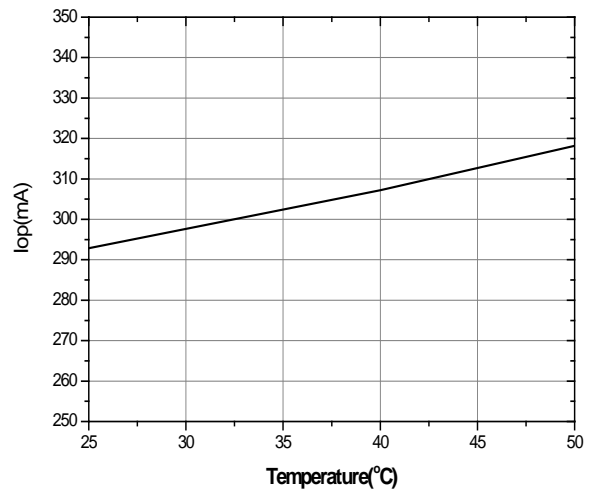
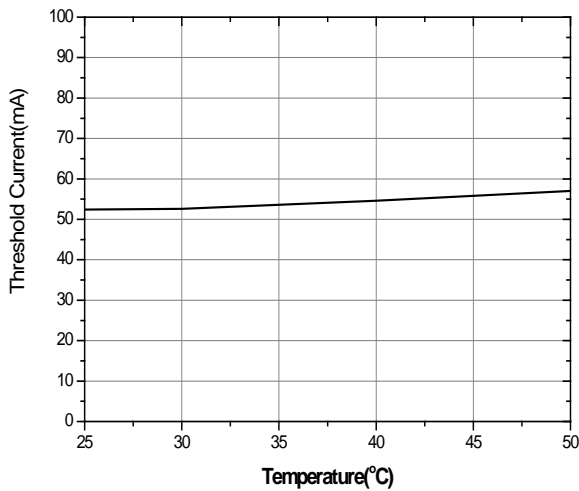
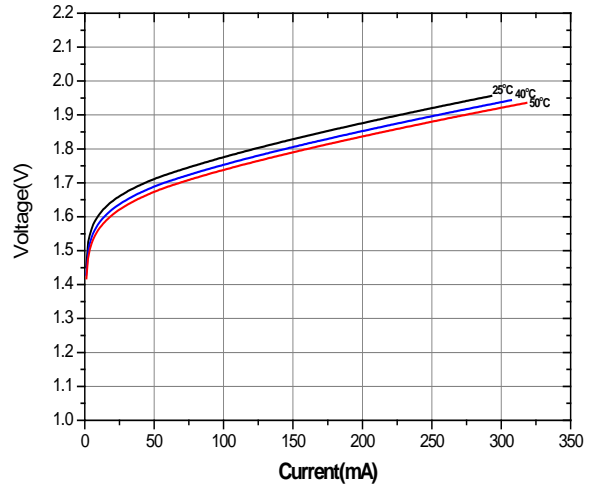
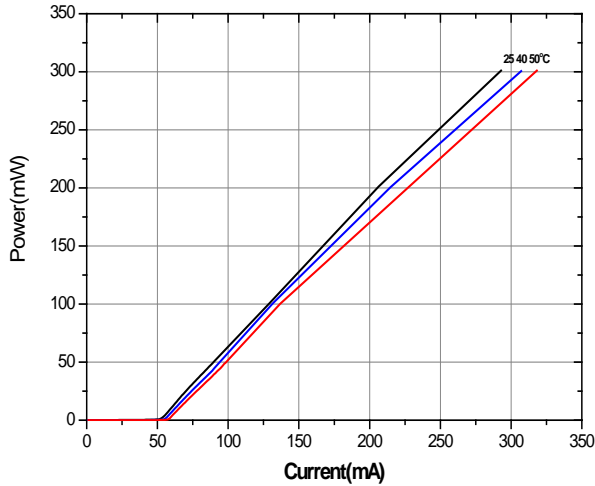

* For reference only. Contents above are subject to change without notice.

Contact

For US, Canada
For EU
For Japan

Ayase America Inc.
Ayase Europe GmbH
Ayase Co., Ltd.

e-mail: info@ayaseamerica.com
e-mail: info@ayase-europe.de
e-mail: info@ayasecorporation.com

+1-408-988-5277
+49-0-6122-533-811
+81-45-532-9501

