

AlGaInP Visible Laser Diode

ADL-65052SL
6-2D-LD65-002_Rev.00

★650nm 5mW 50°C Low Current Operation!

★φ3.3mm Mini Package!

•Features

1. Small package
2. Low operating current
3. High efficiency
4. FFP single lateral mode

•Applications

1. This LD can be used in Class 1 application product
2. Laser pointers
3. Industrial laser markers / measuring instruments
4. Bar code readers

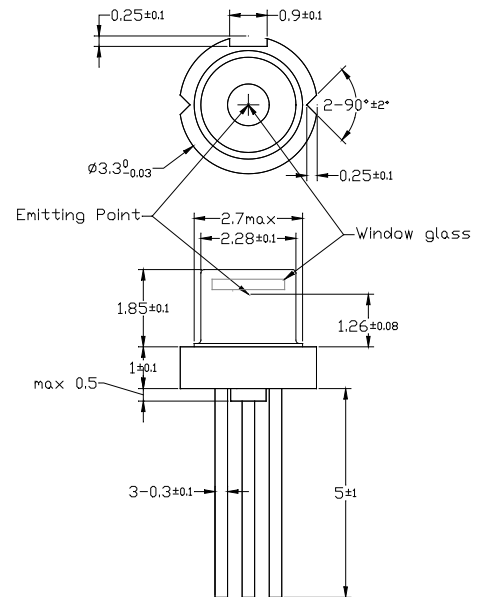

•Absolute maximum ratings

Parameter	Symbol	Condition	Rating	Unit
Light output power	P _O	CW	7	mW
Reverse voltage (LD)	V _{RL}	-	2	V
Reverse voltage (PD)	V _{RD}	-	30	V
Forward current (PD)	I _{FD}	-	10	mA
Case temperature	T _C	-	-10~+50	°C
Storage temperature	T _S	-	-40~+85	°C

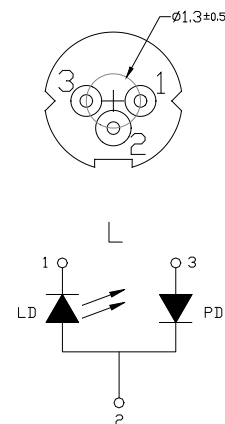

•Electrical and optical characteristics (T_c=25°C)

Parameter	Symbol	Min.	Typ.	Max.	Unit	Conditions
Peak wavelength	λ	645	655	660	nm	P _o =5mW
Threshold current	I _{th}	-	15	20	mA	
Operating current	I _{op}	-	20	22	mA	P _o =5mW
Operating voltage	V _{op}	-	2.2	2.5	V	P _o =5mW
Differential efficiency	η	0.5	1.0	1.4	mW/mA	P _o =3-5mW
Monitor current	I _m	0.05	0.1	0.3	mA	P _o =5mW, V _{RD} =5V
Parallel divergence angle	θ	6	8	12	deg	P _o =5mW
Perpendicular divergence angle	θ _⊥	24	27	32	deg	
Parallel FFP deviation angle	Δθ	-3	0	+3	deg	
Perpendicular FFP deviation angle	Δθ _⊥	-3	0	+3	deg	
Emission point accuracy	ΔxΔyΔz	-80	0	+80	um	

•Precautions

- * Do not operate the device above maximum ratings. Doing so may cause unexpected and permanent damage to the device.
- * Take precautions to avoid electrostatic discharge and/or momentary power spikes. A change in the characteristics of the laser or premature failure may result.
- * Proper heat sinking of the device assures stability and lifetime. Always ensure that maximum operating temperatures are not exceeded.
- * Observing visible or invisible laser beams with the human eye directly, or indirectly, can cause permanent damage. Use a camera to observe the laser.
- * No laser device should be used in any application or situation where life or property is at risk in event of device failure.

* For reference only. Contents above are subject to change without notice.

Contact

For US, Canada Ayase America Inc. e-mail: info@ayaseamerica.com +1-408-988-5277
 For EU Ayase Europe GmbH e-mail: info@ayase-europe.de +49-0-6122-533-811
 For Japan Ayase Co., Ltd. e-mail: info@ayasecorporation.com +81-45-532-9501

AlGaInP Visible Laser Diode

ADL-65052SL

6-2D-LD65-002_Rev.00

* Specifications are subject to change without notice. Ensure that you have the latest specification by contacting us prior to purchase or use of the product.

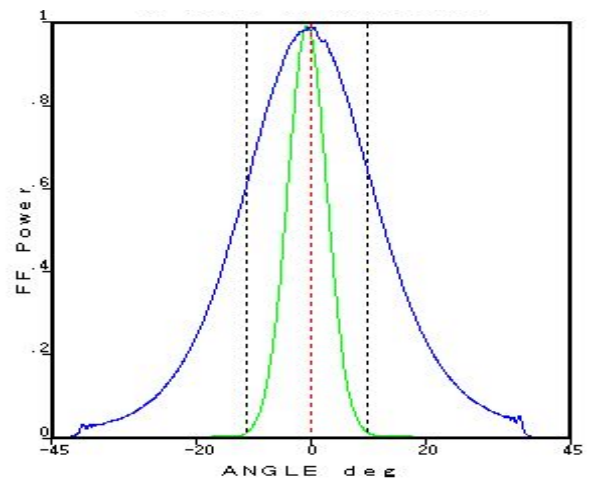
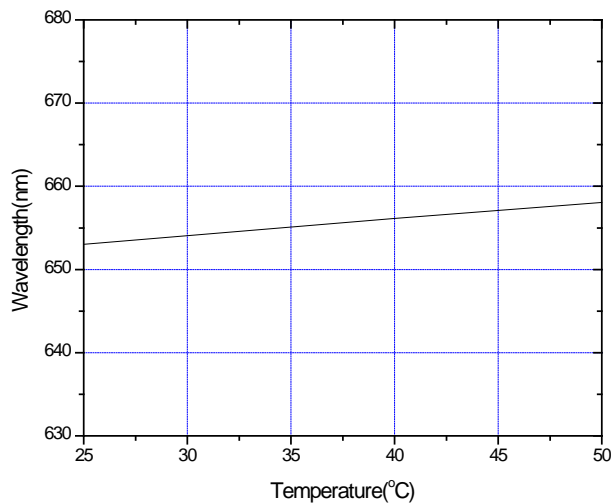
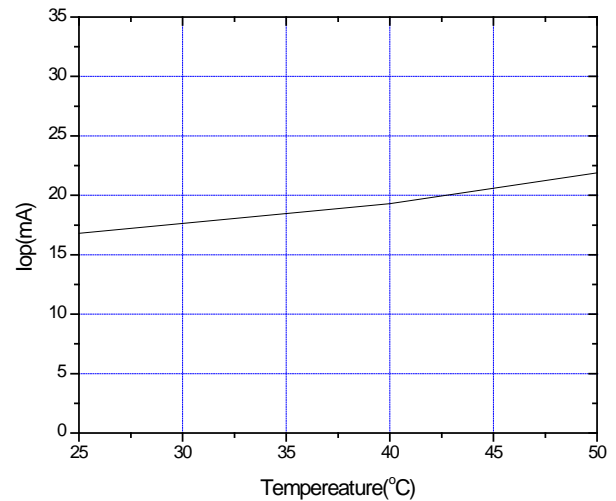
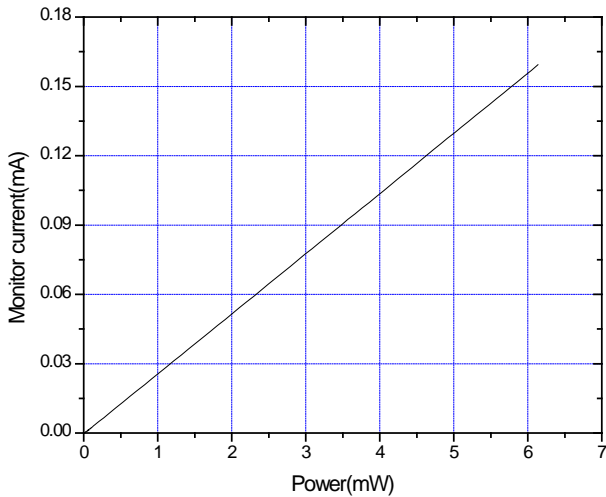
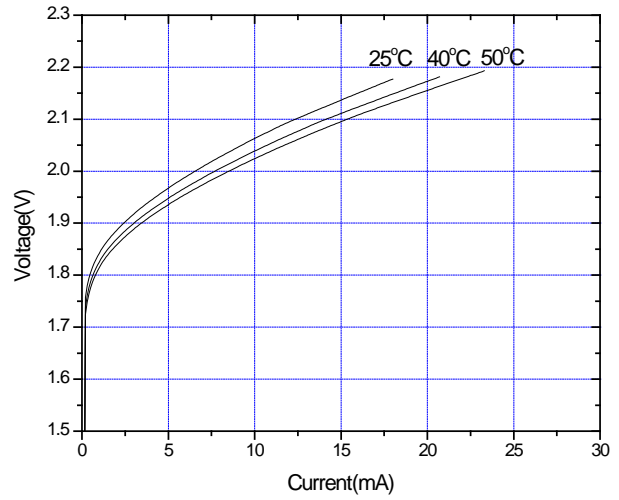
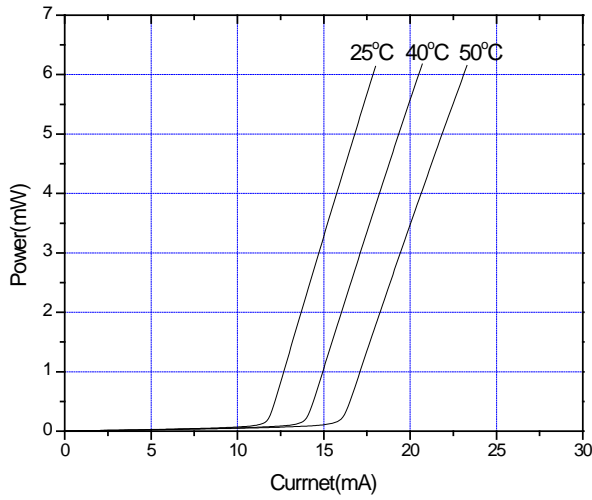

* For reference only. Contents above are subject to change without notice.

Contact

For US, Canada
For EU
For Japan

Ayase America Inc.
Ayase Europe GmbH
Ayase Co., Ltd.

e-mail: info@ayaseamerica.com
e-mail: info@ayase-europe.de
e-mail: info@ayasecorporation.com

+1-408-988-5277
+49-0-6122-533-811
+81-45-532-9501

